



TIPPER RANGE



HINDUJA GROUP

ABOUT ASHOK LEYLAND

Ashok Leyland Ltd., flagship of the Hinduja group, is the 2nd largest manufacturer of commercial vehicles in India. Globally, it is the 3rd largest and the 10th largest manufacturer of buses and trucks respectively. The Chennai-based \$4.2 billion company has 9 manufacturing plants spread across India, UAE, UK and is present across 50 countries. The company has ISO/TS 16949 Corporate Certification and is also the first truck bus manufacturer outside of Japan to win the Deming prize for its Pantnagar plant in 2016 and Hosur Unit II in 2017

Ashok Leyland has a product range from 2T to 55T Gross Vehicle Weight in trucks, 9 to 80 seater buses, vehicles for defence and special applications, diesel engines for industrial, genset and marine applications. The company has also launched the first Indian electric bus.

Ashok Leyland has a strong legacy of introducing industry first solutions with technologies like the 'Sada' or Inline pump for BSIII engines and the unique iEGR technology for BSIV engines. With a passion to carry the legacy forward and create differentiated solutions, the company has indigenously developed a revolutionary BSVI technology. Ashok Leyland is also the first Indian CV manufacturer to get BSVI certification for its full range of heavy duty trucks.

People, Planet and Profit for all stakeholders, including customers, are at the core of Ashok Leyland, which resonates with the **'AAPKI JEET. HAMARI JEET'** philosophy.



ASHOK LEYLAND i-Gen6 ADVANTAGE

Over the years, Ashok Leyland Ltd., strove to deliver performance beyond excellence with inline or 'SAADA' pump for BS-III and iEGR technology for BS-IV.

Now with BS-VI, taking the proven iEGR technology up a notch, we are introducing the i-Gen6 engine technology which enhances the engine performance and durability further. With lower Diesel Exhaust Fluid (DEF) consumption and compact design, i-Gen6 lowers the cost of operation, offering better fluid efficiency and low maintenance. The unique Mid-NOx strategy ensures overall lower cost of ownership.

Innovative



Improved efficiency -

- Controls NOx generation within the engine itself



Lower TCO -

- Lower Diesel Exhaust Fluid (DEF) consumption
- Lower operational cost

Intelligent



Simple functioning -

- Lesser number of sensors



Improved life of Exhaust After Treatment System

- Patented air-assisted DEF injection and unique HC dozer
- Lower maintenance cost

Indian



Mid-NOx technology

- iEGR + SCR
- Higher fluid efficiency



Highly robust -

- Best suited for Indian driving condition

- Superior mileage: Proven iEGR engine combined with innovative air intake system and exhaust treatment offers higher performance
- Longer active regeneration intervals: Ensures longer DPF life
- Compact Exhaust After Treatment System: Allows flexibility in packaging / better space utilisation
- Larger Diesel Exhaust Fluid (DEF) tank: Coupled with lower consumption, ensures less frequent DEF refills
- Shortest first pipe length in exhaust system: Best-in-class thermal management

AVTR - THE ALL NEW TRULY MODULAR TRUCK RANGE

Introducing the revolutionary industry first modular trucks from Ashok Leyland – take your business to the next level.

The modular platform is first of its kind in the Indian CV industry with multiple options of axle configuration, loading spans, cabins, suspensions, drivetrains on a single platform for range of Haulage Trucks, Tippers and Tractors.

Modularity is an approach where the aggregates of a vehicle are divided into smaller sub-aggregates based on functionality and geometry. These sub-aggregates are called modules and have standardized interfaces. This helps in maintaining interchangeability and reducing number of parts.

The aggregates have also been improved in this platform which will ensure higher reliability and low maintenance cost. The modular range comes with range of cabin options with improved safety and comfort features.

The modular range can be customised to individual customer's needs - load, terrain, application and operational requirements.

The Modular platform will deliver higher performance and productivity and will improve Total Cost of Ownership (TCO).

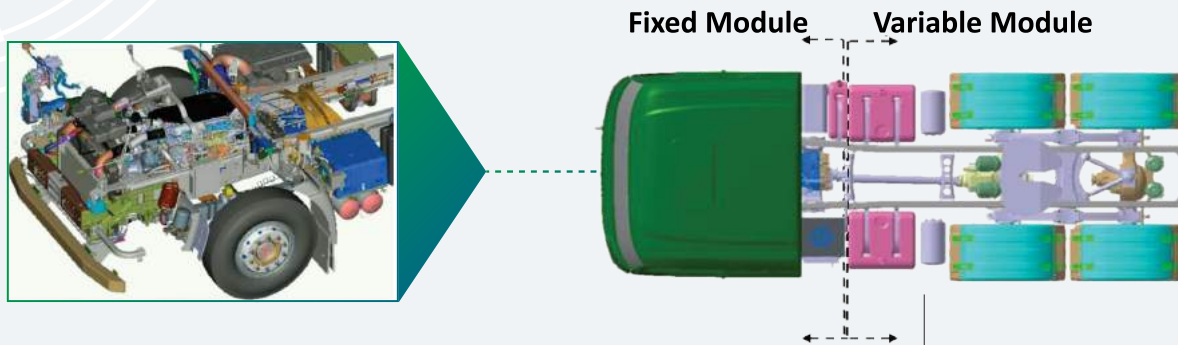

Wide range of Trucks



Wide range of Tippers



Wide range of Tractors

BUILD YOUR OWN TIPPER

Modular design now allows to build your own truck to suit your operational requirements like



Best-in-class
fluid efficiency

Superior Tyre
Mileage

Higher Reliability &
Low Maintenance Cost

Better Productivity &
Performance

Higher Safety

Cabin Options and
Comfort features

Overall TCO
advantage

BEST-IN-CLASS FLUID EFFICIENCY

Choice of iGen6 series engines to suit your load and road requirements



H Series (200 HP)

- Proven iEGR technology carried forward
- Higher power and torque
- Flat torque curve for maximum mileage



A Series (250 HP)

New Improved Cooling System

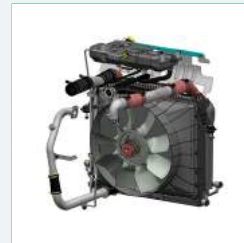

- Wider radiator with centralized cooling fan
- Viscotronic fan clutch reduces fan duty cycle

Heavy Duty Air Compressor & APDA

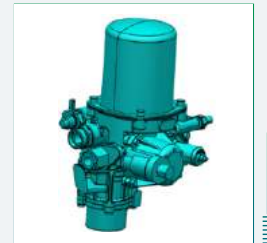

- Larger 318 cc air compressor with APDA - reduced idle time for air build-up

Revolutionary Mid-NOx technology



- Compact EATS
- Air Assisted DEF spray
- Longer Regeneration Interval
- Lowest DEF consumption



Right Driveline



- Selection of right Clutch, Gear Box (& Gear Ratios) and Rear axle (& RAR) as per the Load-Road-Application

Unique HC Dozer

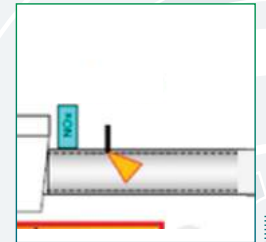

- Unique HC Dozer improves thermal efficiency of EATS
- Less diesel consumption & longer oil change interval compared to late post injection

SUPERIOR TYRE MILEAGE

New Improved Track Rod Levers for Superior Steering Geometry

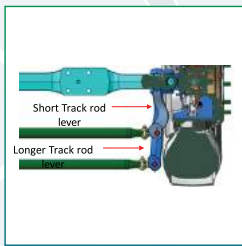

- Different track rod levers based on wheelbases

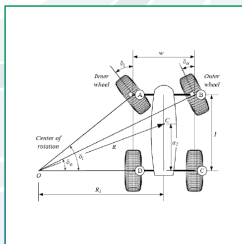

- Improved Ackermann geometry

Parallel U Bolts

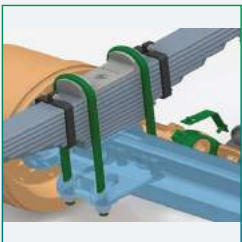

- Parallel U bolts for better torque retention

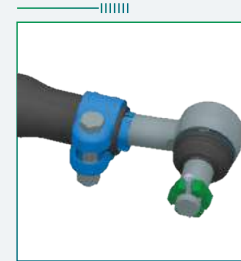

Sealed Ball Joints

- Lubricated for life – low end play
- No need for greasing

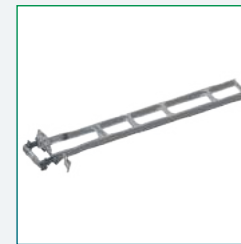

Improved Frame

- HSS steel frame. Frame thickness as per load and road – improved axle alignment
- Fine pitch fasteners for better alignment retention



Wheels & Tyres

- Flow formed wheel rims – better surface finish and alignment
- Tyres spec determined based on Load – Road category



Choice of Suspension

- Suspension choices to suit load/road conditions – no need to add additional spring leaves

HIGHER RELIABILITY AND LOWER MAINTENANCE

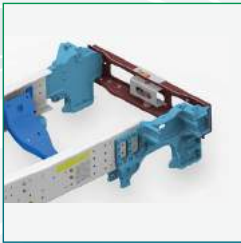

Heavy Duty Components

- All brackets are of heavy duty cast iron – assuring structural rigidity

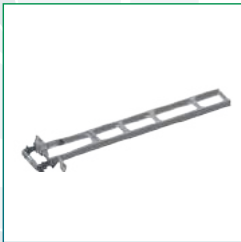

New Improved Frame Design

- Stronger 11" HSS frame with thickness of 8mm to suit Road-Load conditions
- ZAC coated fine pitch fasteners cast iron – assuring structural rigidity

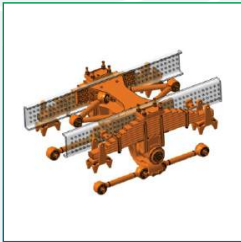

Heavy Duty Bogie Suspension*

- Single piece Cast design
- V-rod and Radius rods are parallel to the ground
- Inverted U-bolt arrangement for ease of accessibility



Grease Free Clutch Operation

- Unilerver Clutch actuation
- Requires no grease
- Smooth gear engagement



Lube for life Propeller Shaft

- No greasing
- Double honeycomb rubber for enhanced damping



Longer Service Intervals

Aggregate	Change Frequency
Engine Oil	1000 Hr for H Series and 500 Hr for A Series
Gearbox Oil	3000 Hr for 9 Speed & 2000 Hr for 6 Speed
Rear axle Oil	2000 Hr
Wheel Greasing	1500 Hrs/ Not Required for Unitised hubs
Fuel Filter	1000 Hr
Clutch Oil	3000 Hr
Steering Oil	4000 Hr
Hydraulic oil	<ul style="list-style-type: none"> • First oil change 6 months • 24 months (12 months for dusty operations)

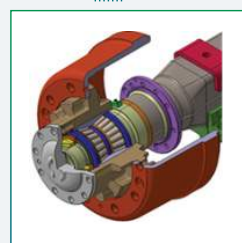

Unitised Wheel Bearings*

- Grease packed for life
- No periodical greasing / adjustment required

HIGHER DRIVING COMFORT AND PERFORMANCE



Higher driving comfort

- All new aerodynamic cab
- Better NVH characteristics
- Choice of 3 Cab options to suit application
- Option of AC and HVAC

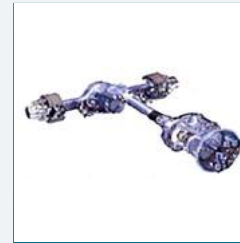

Option of drivetrains

- Option of multiple combination of gear box and rear axle ratios to suit application requirements and increase TAT and productivity

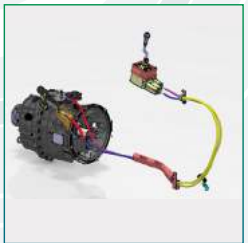

Smoother gearshifts

- Cable gear shift to give smooth gear shifts
- Reduces gear shift effort



Integrated Pedal Unit

- Brake and clutch pedals mounted in single unit
- Eliminates need for brake/clutch setting – ensures longer clutch/brake lining life



Easier steering

- Larger 21LPM steering pump for lower steering effort



Advanced Digital Driver Assistance (ADDA)

- Trip wise distance and KMPL
- Gearshift guidance
- Driver score
- User friendly tell tales

HIGHER SAFETY AND ADD ON FEATURES



All metal front fascia

- Full front fascia made of metal – safety assured
- All metal bumper for easy repairability



Improved visibility

- Double headlamps mounted on bumper
- Wider and long range of visibility
- LED tail Lamps for better visibility and life

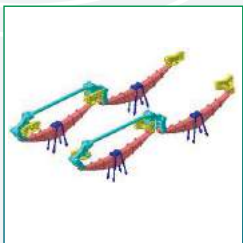

Improved NRS Suspension

- No projection above frame on NRS suspension – Reduces the sub frame height and Centre of gravity

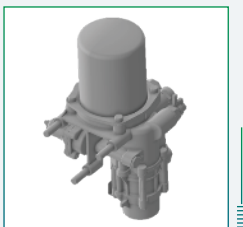

Improved Braking

- Increased system pressure to 10 bar
- Bigger 318 cc Air Compressor
- PTFC (Push To Fit Connectors) for all air piping
- APDA (Air Processing & Distribution Assembly) for drying air and removing oil particles

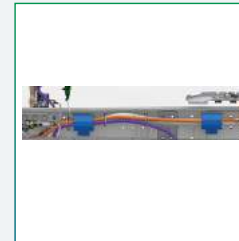

Improved Electricals

- Modular harness – lower no. of unique parts
- Moulded power cables with guided channels for better safety

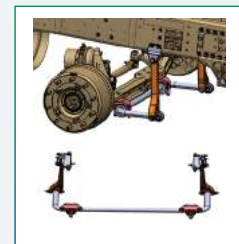

Antiroll Bar

- Anti roll over option for safety and stability



Engine and Exhaust Brake

- Engine brake in A Series engine: improves braking efficiency, specially in gradient
- Exhaust brakes reduces the usage of service brake by upto 60 - 70%, resulting in longer life of the brake linings



Fully Built Options

- Available Box and rock body from 6.5 m³ to 26 m³ capacity
- Increased tail door height
- Anti-rotation chain lock
- High wear resistance steel Rock body
- Anti Toppling kit*

TIPPER APPLICATIONS



Road construction



Blue metal



M sand



River sand



Boulder



Earth work



O B removal



Coal



Iron ore



Limestone



Stone marble



Irrigation



Municipality



Port

AGGREGATE DETAILS

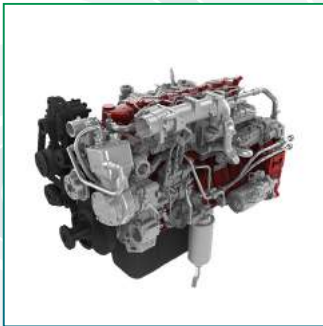

i-Gen6 H series engines

- Power 200HP@ 2400 rpm
- Torque 700Nm@ 1200-2000 rpm
- Noise optimized design
- In-house manufacturing
- Best-in-class mileage
- Lowest fuel costs per ton km
- Easy availability of spares
- Engine oil change at 1000 hrs



i-Gen6 A series engines

- Power 250Hp @ 2200 rpm
- Torque 900Nm @ 1100 - 1800 rpm
- Better fuel efficiency
- Better NVH characteristics
- High power and high torque at low speeds
- In-house manufacturing
- Four valves per cylinder for improved volumetric efficiency

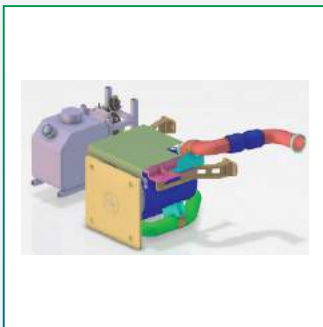

Compact EATS

- Single systems across multiple vehicles
- Compact design
- Higher durability
- Longer DPF regeneration intervals
- Longer DEF filling interval

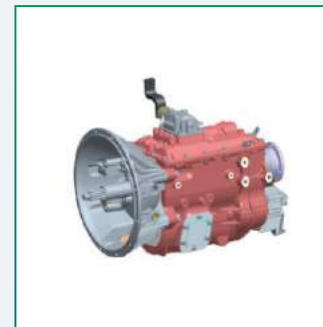

ALGB 940 - 6 speed gearbox

- Bigger gears hence better life
- Smoother gear shifting, fatigue free driving
- Negotiate high gradients with ease
- Low maintenance cost

AGGREGATE DETAILS

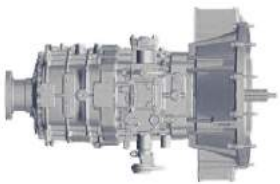

6MT86 Gearbox

- Higher durability
- Improved shift efforts and better durability
- Gearbox configured based on load and road conditions



ZF - 9 Speed Gearbox

- Proven design by ZF, world leaders in gearbox technology
- Higher reliability and durability
 - High gradeability (more than 50%)
 - High load carrying ability
 - Lowest cost of service

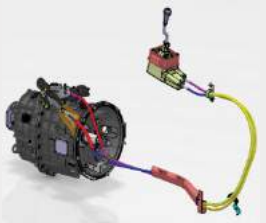

Cable shift CSO

- Better precision gear shift as compared to mechanical rod type CSO
- Gear slippage completely eradicated
- Gear shift effort reduced for lower driver fatigue
- Higher productivity

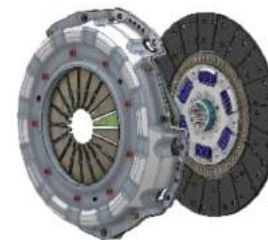

Clutch Assembly

- 380/395mm Dia clutch plates
- Higher clutch plate file
- No greasing points in entire clutch actuation system
- Hydraulic actuation with clutch booster
- Low driving fatigue for longer hours of operation
- Higher durability

AGGREGATE DETAILS

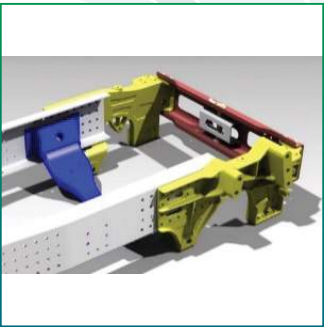

Chassis frame, NODO bracket and cross member

- Stronger, reinforced frame for greater load bearing capability
- High durability due to better material strength
- Only internal 'L' flitch, no external flitch
- Sturdy bracket for integrated mounting and long life
- Smaller fabricated brackets eliminated
- Reduced number of cross member variants
- Clear path for pipe / wiring routing through split gusset

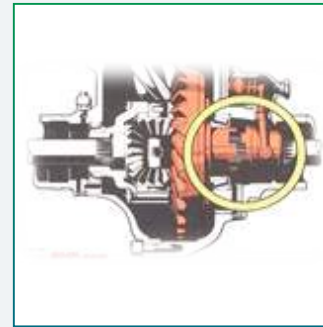

Differential locking mechanism

- Provided on all Ashok Leyland 6x4 and 8x4 Tippers as a standard fitment
- Enhances vehicle traction and allows for operations in demanding applications like sand and river bank



Load body and hydraulics

- High capacity load bearing characteristics
- Faster maintenance as all repairs and warranty decisions are done by Ashok Leyland
- Increased body life of 8000 hours
- Application based load body: heavy duty and light duty
- Improved reliability and durability

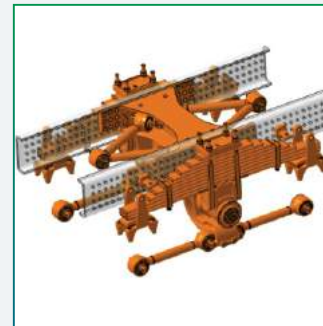

Rear bogie suspension

- Single cast heavy duty design
- Inverted U-bolt arrangement for easy accessibility
- Higher wear pad life
- Reduced tyre scrub - improves tyre life

NEW STRONG AND COMFORTABLE CABIN



M CABIN

U CABIN

N CABIN

M Cabin

- All steel cabin with internal structure and tooled up panels
- Available in day and sleeper versions
- Full Metal front facia
- Crash compliant as per truck code
- Two-piece windshield
- Metal Bumper with twin headlamps
- Lowered footstep for easy entry/exit

U Cabin

- Full metal front facia
- Front pivoted and rear suspended cabin
- Crash compliant as per truck code
- Reclining seats for higher driver comfort
- Anti-roll bar in the front for higher safety
- Optional AC
- Single bigger windshield for better all-round visibility
- Metal bumper with twin headlamps
- Lowered footstep for easy entry/exit

N Cabin

- Tilt able cabin for easy service access
- Suspended driver seat (optional)
- Anti-roll bar in the front
- Excellent overhead, rear and glove box storage space
- Music system
- AC & HVAC (optional)
- Full Metal front facia
- Metal bumper with twin headlamp
- Lowered footstep for easy entry/exit

ADDA: ADVANCED DIGITAL DRIVER ASSIST

Advanced Digital Driver Assist (ADDA) – now a standard feature in all our trucks. This helps the drivers improved their performance significantly. This has features like Gear Shift Advisory System (GSAS), instantaneous fuel economy display, distance to empty gauge, current gear display, DEF gauge, engine hours, air pressure gauge, etc.

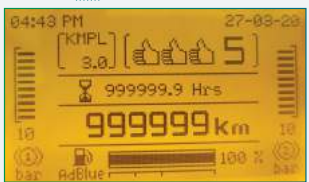
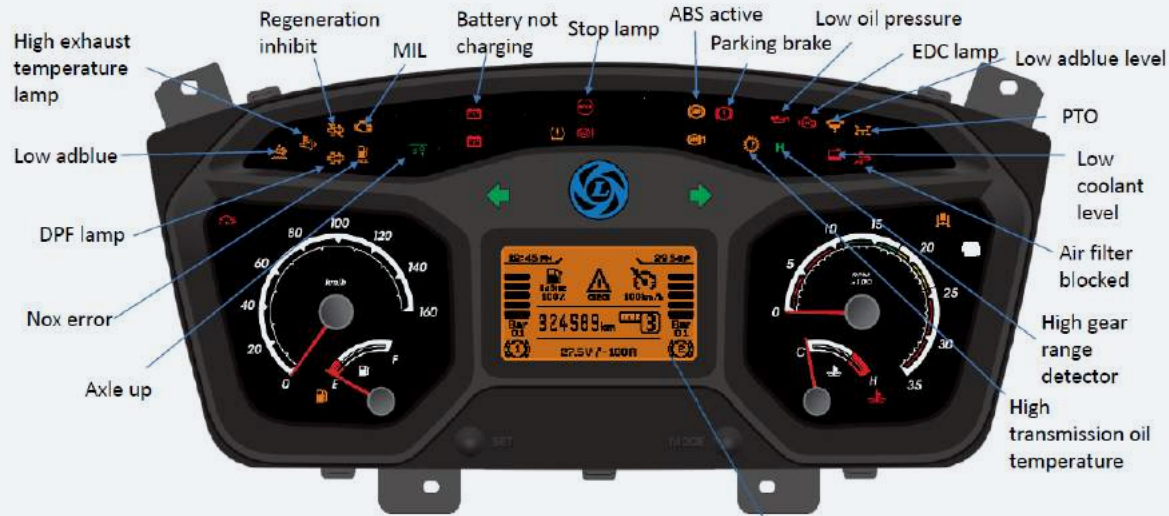

Instantaneous fuel economy display:

- Get KMPL details instantly on the instrument cluster

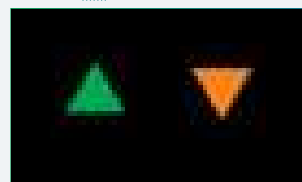

Gear Shift Advisory System (GSAS):

- Non-compliance of the GSAS instructions will show on the instrument cluster through thumbs up and down symbols
- 3 thumbs up for the best compliance. Subsequently goes down to 2 and to 1 thumps ups
- Bad compliance will lead to 1 / 2 / 3 thumbs down

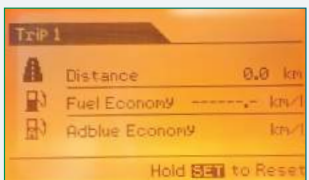

Trip distance and fuel economy:

- Shows the distance and the fuel economy for each trip
- Helps in knowing the distance the vehicle can travel for at the current fuel level

Reverse Park Alert Systems (RPAS):



Assists in reverse driving and parking



Advisory system with beeper sound during reverse addressing detection zone (1800 mm from rear end) and collision zone (800 mm from rear end)

TIPPER RANGE

4x2

1920
TM/TU/TN

6x4

2820
TM/TU/TN

2825
TM/TU/TN

8x2LA

3520
TM/TU/TN

8x4TS

3520
TM/TU/TN

3525
TM/TU/TN

10x2

4220
TM/TU/TN

4225
TM/TU/TN

10x4

4220
TM/TU/TN

4225
TM/TU/TN

3520 SERIES

8X2 TIPPERS



3520 TM

3520 TU

3520 TN



Better fuel
efficiency



Higher Load
carrying capability



Highly reliable
aggregates

3520 SERIES

8X2 TIPPERS

SPECIFICATIONS

Engine type	H series
Engine power	200hp @ 2400rpm
Engine torque	700Nm @ 1200 - 2000 rpm
Clutch	380mm dia single dry plate, ceramic clutch, air assisted hydraulic booster
Gearbox	6 Speed - 2 options 9 speed - 1 option FGR 8.91 and FGR 9.01 FGR 12.73
Rear axle	Fully floating, hypoid differential RAR options: 6.17
Suspension	Front options: semi-elliptic multileaf and parabolic springs Rear: NRS semi-elliptic
Gradeability	Options available 19% and 27%

TCD	19.6M
Brake	Full air dual line with ABS with ASA, drum brakes
Diesel tank capacity	220 / 300 litres
Chassis dimension	275x75x8
Max speed	60 kmph
Tyre options	295/90R20 295/95D20 11x20 16PR 11R20 16PR
Cabin options	M Day, U Day and N Day with AC Option
Chassis weights	Front Laden: 7000 LA Laden: 7000 Rear Laden: 21000

Wheelbase(mm) 5450

Body capacity 20 m³
Box

SCHEMATIC LAYOUT

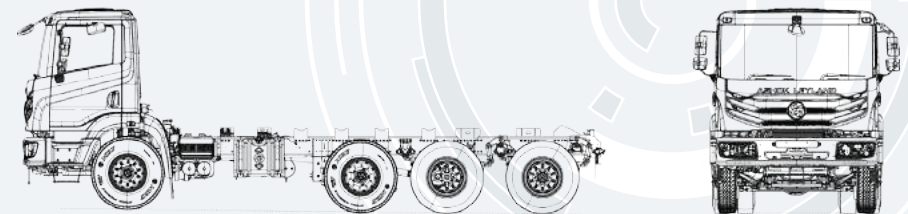

3520 SERIES

8X4 TIPPERS



3520 TN

3520 TM

3520 TU



Higher productivity



Higher uptime



Faster turnaround
time

3520 SERIES

8X4 TIPPERS

SPECIFICATIONS

Engine type	H series	
Engine power	200hp @ 2400rpm	
Engine torque	700Nm @ 1200 - 2000 rpm	
Clutch	380mm dia single dry plate, ceramic clutch, air assisted hydraulic booster	
Gearbox	6 Speed - 2 options FGR 8.91 and FGR 9.01	9 speed - 1 option FGR 12.73
Rear axle	Fully floating, hypoid differential RAR options: 6.17	
Suspension	Front option: semi-elliptic multileaf and parabolic springs Rear: NRS semi-elliptic and bogie	
Gradeability	Options available 18 and 27%	

TCD	18.94M
Brake	Full air dual line with ABS with ASA, drum brakes
Diesel tank capacity	220 / 300 litres
Chassis dimension	275x75x8+6
Max speed	60 kmph
Tyre options	295/90R20 295/95D20 11x20 16PR 11R20 16PR
Cabin options	M Day, U Day and N Day with AC Option
Chassis weights	Front 1 Laden: 7000 Front 2 Laden: 7000 Rear Laden: 21000

SCHEMATIC LAYOUT

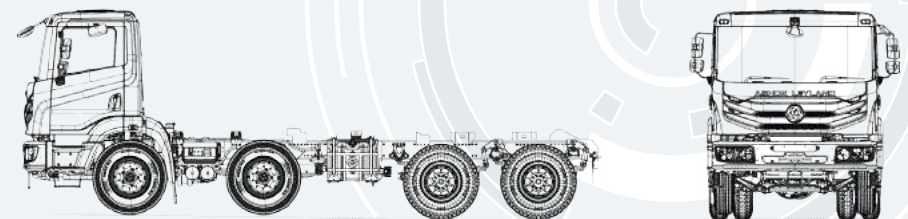

Wheelbase(mm)	5250	5250	5250	5250	5250
Body capacity	CAB CHASSIS	16 m ³ BOX	18 m ³ Box	20 m ³ Box	22 m ³ Box

iALERT – THE NEXT GEN NAVIGATION ASSISTANT



Route Management



Fuel Management



Trip Management



Service Reminders



Reports and Analytics

Ashok Leyland iALERT, a pioneering product that helps you monitor your vehicle using near real time data. It has been enhanced to accommodate the technical complexities of BSVI, offering a simplified yet intuitive approach to monitor vehicle parameters. It provides deep insights that enables you to take faster decisions. This home-grown system can monitor 100+ parameters at high sampling frequencies 'on the edge'. It enables prognostic models to predict failures and ensures vehicle up time and also provide proactive service support.

Key features of iALERT

Much More than Diagnostics:

- It can pre-empt issues before they occur, giving the operators the power to avoid glitches and steer clear of unforeseen expenses or unplanned delays

10x Benefits:

- It offers diverse benefits including VHMD, Track and Trace, Geo fencing, Trip Management, Route deviation tracking, Fuel level management, Alerts and Reports, Service reminders, Driver monitoring, Fleet management & Dealer locator.

Unmatched Response Time:

- Since the on-ground team is relayed complete details about vehicle position and health, the turnaround time for resolution is cut short tremendously, whether critical alert, minor repair or service due.

Proactive Service Support

- By tracking all Ashok Leyland vehicles coming within their geographical purview, our dealers are better equipped to offer support when and where needed.

AFTERMARKET NETWORK - 24X7 SUPPORT FOR YOU

Our objective is to always be there for our customers. With this in mind, we aim to increase our network quality and reach across India for easier accessibility of sales, service and spare parts and to maintain a consistent and enriched customer experience. We offer quick support on the highway with 18,000 technical associates through Service Mandi.

Static outlets

Dynamic outlets



Dealer Type A+



Dealer Type A



Onsite Service (SASSY)



Quick Service (WOW)



Dealer Type B



Dealer Type C



Dealer Type D



ALASC

Touch points	Numbers
Dealers	340+
ASC	290+
Sassy	90+
WOW	180+
Primary touch points	1000+
Mechanic club members	1400+



- Ashok Leyland Authorized Dealer
- Ashok Leyland Onsite Service
- ▲ Ashok Leyland Authorized service
- 🚚 Ashok Leyland Quick Service

e-DIAGNOSTICS

- Mobile phone - Bluetooth connectivity based diagnostic app to pinpoint the error code of the vehicle ECU
- Guided trouble shooting list pops up to help the technician solve the error
- Step by step visual aids for the technician

LEYKART

- Offers round the clock availability of spare parts
- Easy search for parts using the vehicle number
- Secure online payment options
- Track orders on mobile and get parts delivered to doorstep



SERVICEMANDI

- Connects digitally trained and certified workshops across the country
- Hassle-free service experience through mobile apps
- Live updates of vehicle repair on mobile

RECON

- Factory built high quality reconditioned engines
- Dynamometer tested engines offering high reliability and performance
- Pan India warranty

LEYPARTS®

- Comprehensive range
- Value for money
- Available at the nearest outlet
- Now in tamper-proof, newly designed cartons

VALUEPARTS

Right fit for Ashok Leyland vehicles

- Right fit for Ashok Leyland vehicles

QUICK RESPONSE

- Response within 4 hours
- Restoration within 48 hours

EXTENDED WARRANTY

- Extended warranty available for longer coverage / period
- Quality and skilled manpower
- Improved TAT
- Genuine spare parts
- Competitive pricing
- Insulates customer from unknown failures / expenses
- Pan India support

AMC

- One-stop service solutions
- Flexible maintenance packages
- Pan India service
- Better resale value

SERVICE TRAINING

- Training service team to ensure quality, productivity and profitability

DRIVER TRAINING

- 11 Driver Training Institutes across India
- Institutes equipped with contemporary vehicles, simulators and modern infrastructure
- State-of-the-art training for drivers of customers, fleet owners and general public

HELPLINE

1800-266-3340

AUTHORISED DEALER:



Registered Office - Ashok Leyland Limited, No. 1, Sardar Patel Road, Guindy, Chennai - 600032, Tel. - +91 44 2220 6000
E-mail - reachus@ashokleyland.com | Website - www.ashokleyland.com | Helpline Number - 1800 266 3340

Specifications given in the booklet are subject to change



HINDUJA GROUP